

I. General

1. Pipes

(1) Name: S ductile iron pipe

Abbreviation: S

Symbol of pipe: 

(2) Pipe size: 44" to 104" (1100 mm to 2600 mm)

(3) Pipe wall thickness: Class 1, 2 and 3

2. Structure of pipes

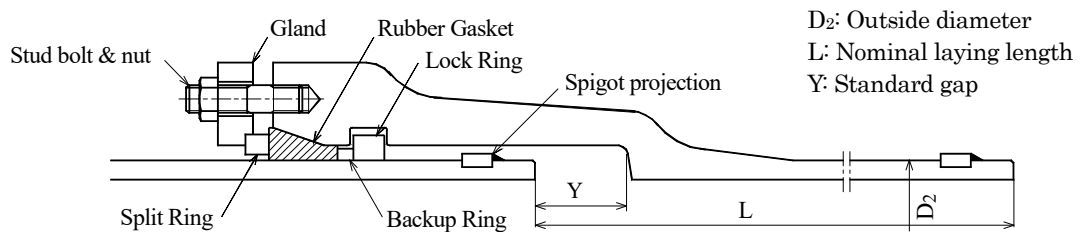

Figure-1 Joint structure of pipe

Table-1 Dimensions of pipes

Pipe size, in. [mm]	Outside diameter, D ₂ in. [mm]	Nominal laying length, L ft. [m]	Standard gap, Y in. [mm]
44 [1100]	45.04 [1144]	19.69 [6]	3.15 [80]
48 [1200]	49.06 [1246]		
54 [1350]	55.12 [1400]		
60 [1500]	61.18 [1554]	13.12 [4] or 16.40 [5]	2.95 [75]
64 [1600]	64.96 [1650]		
66 [1650]	66.97 [1701]		
72 [1800]	72.76 [1848]		
80 [2000]	81.14 [2061]		
84 [2100]	85.20 [2164]	13.12 [4]	3.15 [80]
88 [2200]	89.76 [2280]		
96 [2400]	96.77 [2458]		
104 [2600]	105.67 [2684]		3.35 [85]

3. Fitting

(1) Type of fitting: Collar

(2) Structure of Collar

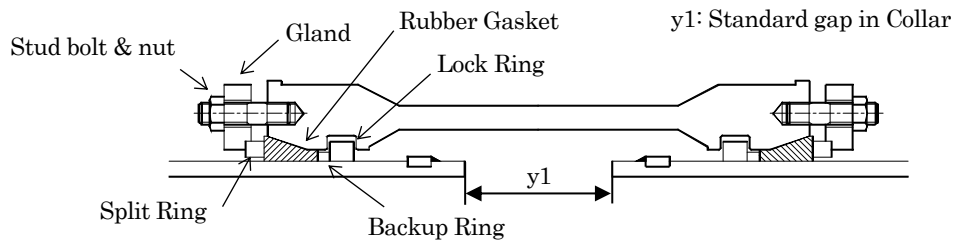

Figure-2 Joint structure of Collar

Table-2 Standard gap in Collar for tie-in

Pipe size in. [mm]	Standard gap in Collar, y1 in. [mm]
44 [1100]	11.8 [300]
48 [1200]	
54 [1350]	12.2 [310]
60 [1500]	12.6 [320]
64 [1600]	12.8 [325]
66 [1650]	
72 [1800]	13.0 [330]
80 [2000]	13.2 [335]
84 [2100]	13.8 [350]
88 [2200]	
96 [2400]	
104 [2600]	14.6 [370]

4. Accessories

(1) Connecting Pieces of Lock Ring

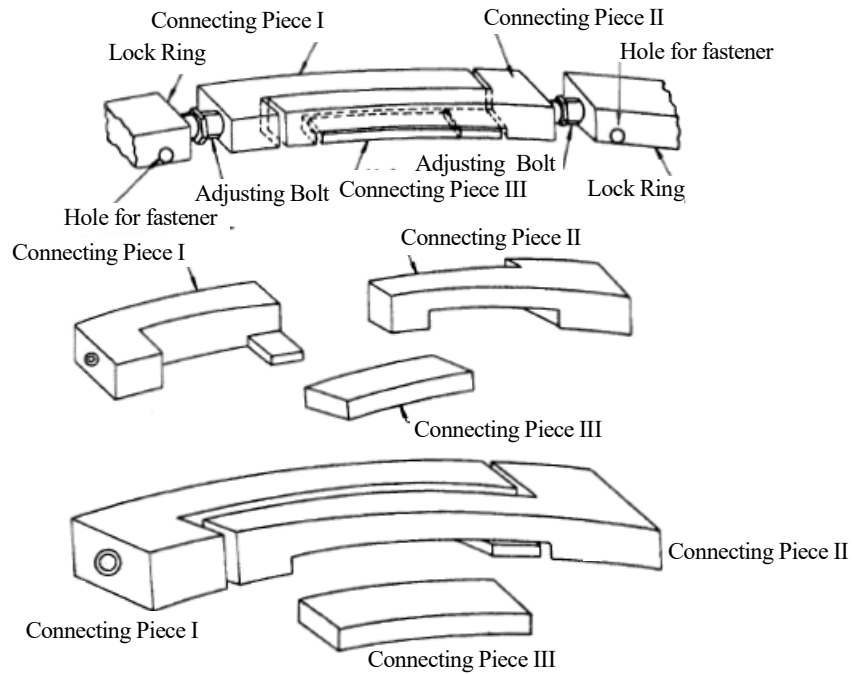

Figure-3 Connecting Pieces of Lock Ring

(2) Materials of accessories

- 1) Rubber Gasket: SBR (EPDM)
- 2) Gland: Ductile iron
- 3) Split Ring: Ductile iron
- 4) Stud bolt and nut: Stainless steel
- 5) Lock Ring: Ductile iron
- 6) Connecting Pieces and Adjusting Bolt: Stainless steel
- 7) Backup Ring: SBR (EPDM)

5. Standard performance

(1) Expansion and contraction

Table-3 Expansion and contraction of pipe and Collar

Pipe size, in. [mm]	Pipe, in. [mm]	Collar, in. [mm]	
		Expansion	Contraction
44 [1100]	±3.09 [±78.5]	+5.27 [134]	-11.81 [300]
48 [1200]		+5.27 [134]	-11.81 [300]
54 [1350]		+6.06 [154]	-12.20 [310]
60 [1500]	±3.18 [±81.0]	+5.27 [134]	-12.59 [320]
64 [1600]	±2.85 [±72.5]	+5.70 [145]	-12.79 [325]
66 [1650]		+5.70 [145]	-12.79 [325]
72 [1800]	±2.95 [±75.0]	+5.51 [140]	-12.99 [330]
80 [2000]	±3.05 [±77.5]	+4.92 [125]	-13.18 [335]
84 [2100]	±3.14 [±80.0]	+5.51 [140]	-13.77 [350]
88 [2200]		+5.51 [140]	-13.77 [350]
96 [2400]	±3.24 [±82.5]	+5.51 [140]	-13.77 [350]
104 [2600]	±3.36 [±85.5]	+5.11 [130]	-14.56 [370]

(2) Allowable deflection angle

Table-4 Allowable deflection angles of pipe and Collar (on one side)

Pipe size, in. [mm]	Allowable deflection angle (at installation)	Maximum deflection angle
44 [1100]	1.67° [1°40']	7.00° [7°00']
48 [1200]	1.50° [1°30']	
54 [1350]		6.50° [6°30']
60 [1500]		5.83° [5°50']
64 [1600]		5.00° [5°00']
66 [1650]		4.83° [4°50']
72 [1800]		4.67° [4°40']
80 [2000]		4.33° [4°20']
84 [2100]		4.17° [4°10']
88 [2200]		4.00° [4°00']
96 [2400]		3.83° [3°50']
104 [2600]		3.67° [3°40']

(3) Pull-out resistance force

Table-5 Pull-out resistance force

Pipe size, in. [mm]	Pull-out resistance force, lbf [kN]
44 [1100]	748,000 [3,300]
48 [1200]	816,000 [3,600]
54 [1350]	918,000 [4,050]
60 [1500]	1,020,000 [4,500]
64 [1600]	1,088,000 [4,800]
66 [1650]	1,122,000 [4,950]
72 [1800]	1,224,000 [5,400]
80 [2000]	1,360,000 [6,000]
84 [2100]	1,428,000 [6,300]
88 [2200]	1,496,000 [6,600]
96 [2400]	1,632,000 [7,200]
104 [2600]	1,768,000 [7,800]

II. S Pipe assembly procedure

Follow this manual to assemble the S joint correctly. Always ensure the accessories and pipes are clean before installation. It is recommended that the joint assembly process and results be checked with a “Joint check sheet” to ensure the joint performance quality.

1. Pipe set-up

Locate the manufacturer’s mark at the center of the bell top.

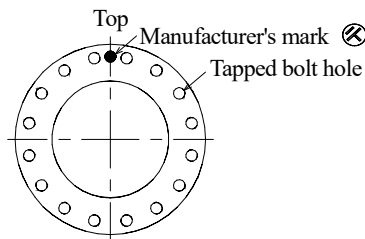

Figure-4 Pipe set-up

2. Cleaning and outside diameter check

Clean the socket surface (especially the Rubber Gasket groove) and spigot surface (to about 2 feet from the spigot end). Remove all foreign materials, such as dirt, sand, and oil.

Check the outside diameter of the spigot to ensure it conforms to the outside diameter allowance range if necessary, especially when using a cut-end spigot.

3. Lock Ring adjustment

(1) Screw the Adjusting Bolt into the tapped holes located at the ends of the Lock Ring and the Connecting Piece I. At this point, screw in only one or two threads. (See Figure-5.) Ensure the Lock Ring hole for the Lock Ring Fastener and the Connecting Piece slot are aligned in the same direction.

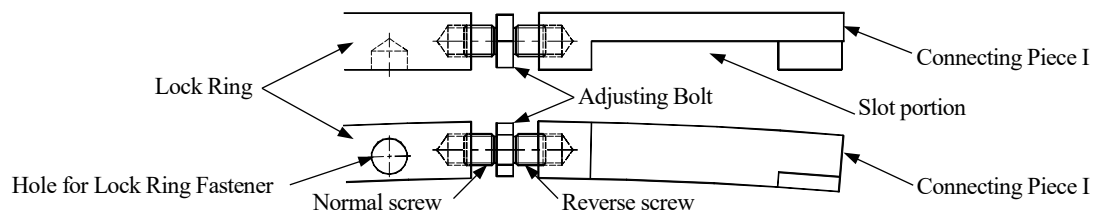

Figure-5 Connecting Piece I and Adjusting Bolt

(2) Assemble the Connecting Piece II to the other side of the Lock Ring with another Adjusting Bolt in the same manner as Connecting Piece I. (See Figure-6.)

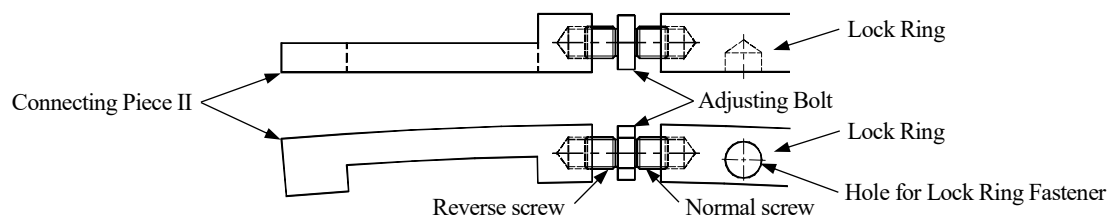
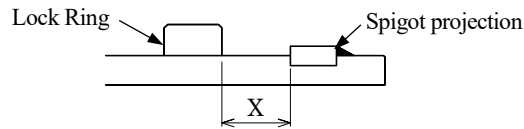

Figure-6 Connecting Piece II and Adjusting Bolt of Lock Ring

(3) Place the Lock Ring on the pipe spigot for size adjustment. Locate the Connecting Pieces I and II at the top of the spigot. Ensure both the Lock Ring holes for the fastener and the Connecting Piece slot face the opposite side of the spigot projection, not toward the spigot end. Maintain the Lock Ring at a straight angle to the spigot. Place the Lock Ring at a distance X from the spigot projection, as shown in Table-6.

Table-6 Lock Ring position on pipe spigot



Pipe size, in. [mm]	X, in. [mm]	Pipe size, in. [mm]	X, in. [mm]
44 [1100]	3.2 [80]	80 [2000]	3.2 [80]
48 [1200]		84 [2100]	
54 [1350]		88 [2200]	
60 [1500]		3.3 [85]	96 [2400]
64 [1600]	104 [2600]		
66 [1650]			
72 [1800]	3.0 [75]		

(4) Set up the Lock Ring Fastener on the pipe. Insert both the pointing portions of the fastener into the holes of the Lock Ring. Then tighten the fastener nut by hand until the Lock Ring lightly contacts the spigot surface. (See Figure-7.) Ensure the Lock Ring and spigot projection are positioned parallel to the spigot end around the spigot.

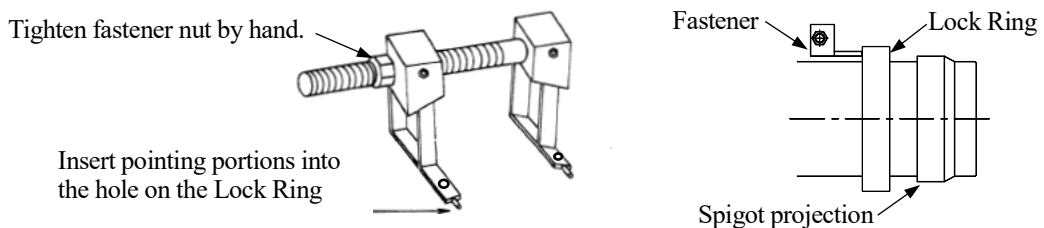

Figure-7 Lock Ring Fastener

(5) Keep tightening the fastener nut to complete contact with the Lock Ring and the spigot surface. Insert the Connecting Piece III into the Connecting Piece slot. Turn both Adjusting Bolts to fine-tune the gap between Connecting Pieces II and III from 1.5 mm to 2.0 mm. (See Figure-8.) Balance the “a” and “b” gaps between the Lock Ring and Connecting Pieces to the same distances.

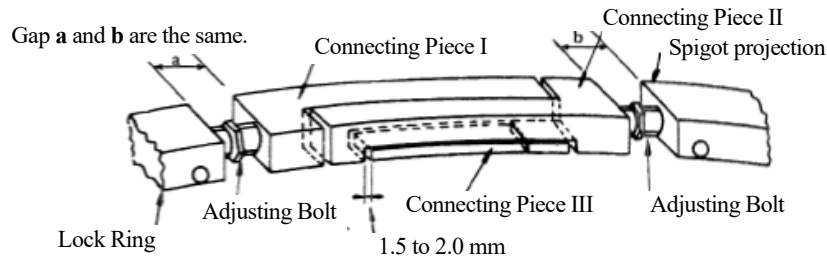

Figure-8 Adjustment of Lock Ring Connecting Pieces

- (6) Release and remove the Lock Ring Fastener from the Lock Ring. Ensure there are no gaps over 1 mm between the Lock Ring and the spigot surface around the spigot in a wide range. A 1-mm thickness gauge may be used to check the gaps.
- (7) Remove the Lock Ring from the spigot by spreading the Lock Ring Fastener. Keep the Connecting Pieces from turning while removing the Lock Ring.

4. Installing Lock Ring

- (1) Install the Lock Ring in the groove of the inside socket. Locate the Connecting Pieces I and II at the top of the socket. Keep the Connecting Pieces from turning while installing the Lock Ring.
- (2) Spread the Lock Ring with the Lock Ring Expander so that the whole Lock Ring is securely installed in the groove of the socket. (See Figure-9.)

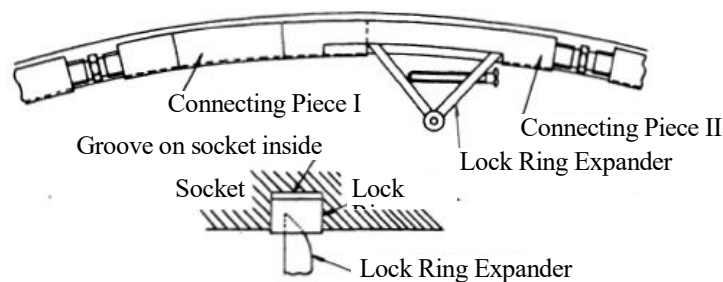

Figure-9 Expansion of Lock Ring with Lock Ring Expander

**CAUTION**

Do not put your hands between the socket and the Lock Ring while installing it. Your hands may be pinched, causing a severe injury.

**CAUTION**

Install the Lock Ring correctly to maintain the full performance of the pull-out resistant function of the joint.

5. Installing gland and Split Ring

Place the gland onto the spigot first, ensuring the orientation is correct (the dip must face the spigot end). Next, place the Split Ring onto the spigot. (See Figure-10.) Locate the split portion of the Split Ring at the bottom of the pipe.

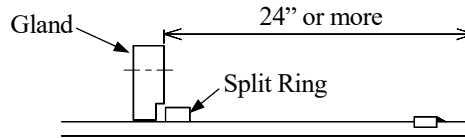

Figure-10 Installation of gland and Split Ring on the spigot

6. Installing Rubber Gasket and Backup Ring

(1) Apply some lubricant to the spigot surface and the inside socket. (See Figure-11.)

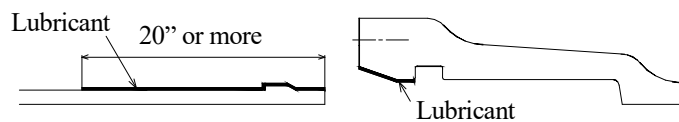

Figure-11 Lubrication

(2) Confirm the joint type indication mark “S” on the backside of the Rubber Gasket. Apply some lubricant to the inside surface of the Rubber Gasket, then place the Rubber Gasket onto the spigot, ensuring the gasket is not inside out, followed by the Backup Ring. (See Figure-12.) Ensure the reinforcement metal of the Backup Ring faces the spigot end. (See Figure-13.)

Note: Joint type indication marks on the backside of the Rubber Gasket are labeled like below.

- a) 40”-96” (1000-2400): U. S. US
- b) 104” (2600): U. UF. S. US

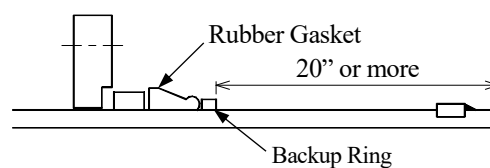

Figure-12 Rubber Gasket and Backup Ring

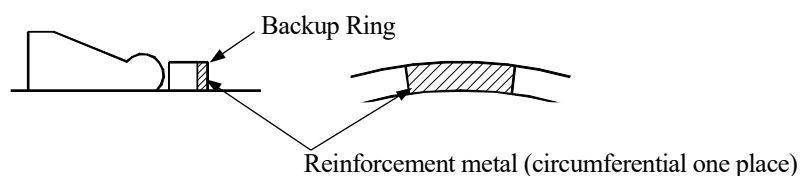

Figure-13 Reinforcement metal of Backup Ring



CAUTION Confirm the Rubber Gasket's and Backup Ring's orientation before placing them on the spigot. Incorrect positions of the accessories will lead to leaks.

**CAUTION**

Select the correct Rubber Gasket and Backup Ring conforming to the S-type joint and pipe size. Incorrect accessories will lead to leaks.

**CAUTION**

Refrain from using a disassembled Rubber Gasket. Reuse of a disassembled Rubber Gasket will lead to leaks.

7. Insertion of spigot into socket

(1) Place joint spacers (rubber, plastic, steel, wood, etc.) in the socket. (See Figure-14.)

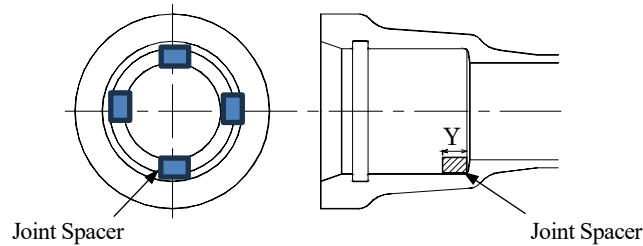

Pipe size, in. [mm]	Y, in. [mm]
44 [1100]	3.2 [80]
48 [1200]	
54 [1350]	
60 [1500]	
64 [1600]	3.0 [75]
66 [1650]	
72 [1800]	

Pipe size, in. [mm]	Y, in. [mm]
80 [2000]	3.2 [80]
84 [2100]	
88 [2200]	
96 [2400]	3.3 [85]
104 [2600]	

Figure-14 Joint Spacer

(2) Insert the spigot slowly into the socket and stop inserting when the spigot end touches the spacers. (Attempt the same action when inserting the socket into the spigot as well.) The Lock Ring Expander falls inside the pipe as the spigot passes the Lock Ring. During this process, keep the Lock Ring Expander from getting caught between the socket and the spigot. If inserting the spigot fails due to a fall of the Lock Ring Expander, reinstall it and check the alignment of the pipes before attempting again.

The pipe may have an assembly guideline on the spigot to indicate the insertion depth. When inserting the spigot, the bell end should match the assembly guideline.

8. Engaging Lock Ring

- (1) Align the joint before engaging the Lock Ring. Maintain an adequate space at the top of the joint for the Lock Ring Fastener. Insert both the pointing portions of the fastener into the holes of the Lock Ring. Turn the fastener nut by hand and with a wrench to make space in the slot for the Connecting Piece III. Hold the fastener securely to avoid coming apart from the fastener while turning the fastener nut. Do not overturn the nut. (See Figure-15.)

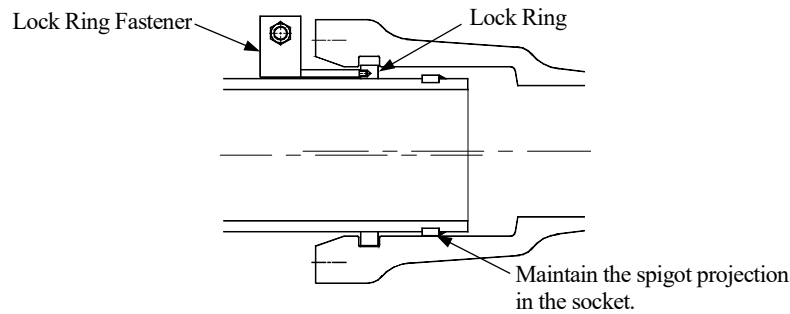

Figure-15 Lock Ring Fastener and Lock Ring

- (2) Insert the Connecting Piece III into the slot between the Connecting Pieces I and II. (See Figure-16.) Then, release and remove the Lock Ring Fastener to engage the Lock Ring.

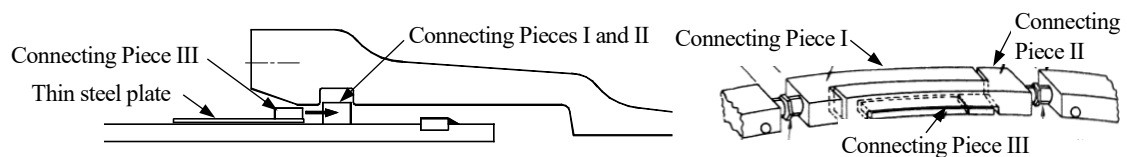

Figure-16 Insertion of Connecting Piece III

After engaging the Lock Ring, visually and with a gauge, check if it is securely set up around the spigot. Ensure there are no gaps over 1 mm between the Lock Ring and the spigot surface around the spigot in a wide range along the circumference (approximately 1/8 of the circumference) of the Lock Ring. A 1-mm thickness gauge may be used to check the gaps.

9. Installation of Backup Ring

Adjust vertical and horizontal joint clearances to maintain uniform gaps between the inside socket and the spigot surface. Adjust the Backup Ring metal position to align it with the Connecting Pieces. Insert the metal surface into the socket completely with a stabbing tool, and then continue to insert the rest of the Backup Ring into the socket. For the complete insertion, the Backup Ring must touch the Lock Ring around the joint. The joint gap clearance may be adjusted during this process.

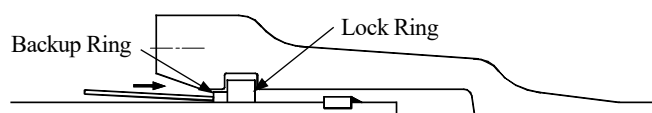

Figure-17 Insertion of Backup Ring

10. Installation of Rubber Gasket

- (1) Apply lubricant to the external surface of the Rubber Gasket (especially to the bulb portion) as well as the spigot and socket surfaces if the previous lubricant has been dried or inadequate.
- (2) Push the Rubber Gasket into the socket. Do not push it with sharp-edged tools, such as a chisel, as this may damage it.

11. Installation of stud bolts

Remove all the bolt-hole caps on the bell end. Remove foreign materials on the bolt threads. (No anti-seize treatment is required.) Screw the shorter threads into the tapped holes on the bell end face.

12. Installation of Split Ring and gland

- (1) Shift the Split Ring toward the Rubber Gasket. Ensure the split portion of the Split Ring is located at the bottom center of the joint.
- (2) Shift the gland toward the bell. Align the bolt holes of the gland and the bolt holes on the bell end. Center the gland with wedges placed between the gland and the spigot at the pipe top. (See Figure-18.) Fasten several nuts by hand to adjust the gland to a snug position. Never damage the threads of the stud bolts during this step.

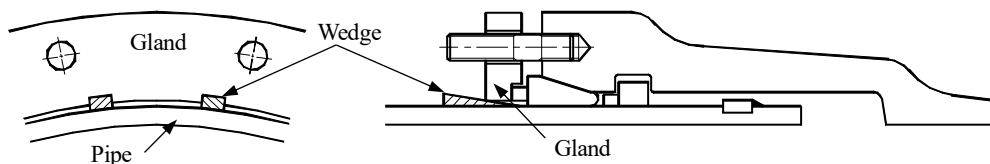

Figure-18 Centering of gland

- (3) Ensure the dip of the gland is placed on the Split Ring around the pipe. Ensure the split portion of the Split Ring is located at the pipe bottom and is closed, not open. (If the split portion is widely open, the gland might not be correctly placed on the Split Ring and does not sufficiently compress the Rubber Gasket.)

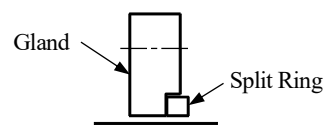

Figure-19 Gland and Split Ring

- (4) Follow the steps below to tighten the bolts and nuts. During these steps, always pay attention to the Rubber Gasket positions to maintain a balanced Rubber Gasket appearance.
 1. Find the widest and narrowest gaps of the gland and the bell end.
 2. Start tightening the nuts where the gap is widest.

- If the gap is all even around the joint, start tightening the nuts where the Rubber Gasket is harder to insert and where the gap between the socket and the spigot is narrow.
- Maintain the even balance by tightening the nuts alternately while the joint is assembled. (See Figure-20).

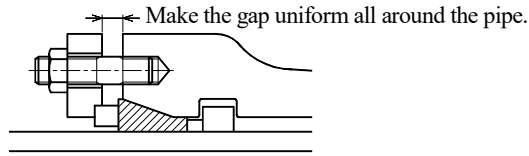
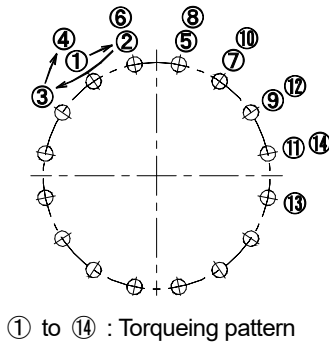



Figure-20 Gap between gland and bell end face

- Check the torque of all bolts and nuts with a calibrated torque wrench in the order shown in Figure-21.



Pipe size, in. [mm]	Bolt diameter, mm	Standard tightening torque, ft-lb, [N-m]
44 to 104 [1100 to 2600]	M30	147.4 [200]

Figure-21 Torque check order and standard tightening torque

 **CAUTION** Ensure to use a calibrated torque wrench.

 **CAUTION** Over-torquing will result in potential leaks.

- Remove the joint spacers and the Lock Ring Expander from the inside pipe.

13. Installation with a deflection at the joint

(1) Follow “1. Pipe set-up” through “12. Installation of Split Ring and gland” of Clause II.

(2) After completing the assembly, deflect the joint to the desired angle.

(3) Table-7 shows the allowable deflection angle of the joint. Do not exceed the allowable deflection angle. Utilize multiple joints to accommodate large deflection angles that exceed a single joint allowable deflection angle.

Table-7 Allowable deflection angle and deviation

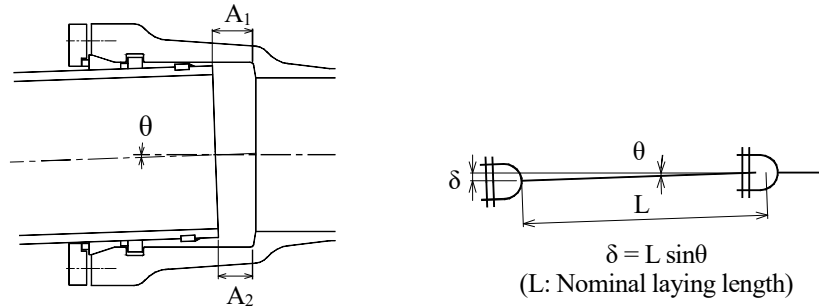

Pipe size, in. [mm]	Allowable deflection angle θ	$A_1 - A_2$, in. [mm]	Allowable offset δ , in. [mm]					
			L=13.12'	L=16.40'	L=19.69'			
44 [1100]	1.67° [1°40']	1.30 [33]	-	-	6.69 [17]			
48 [1200]	1.50° [1°30']	1.30 [33]			3.93 [10]	5.11 [13]	-	
54 [1350]		1.46 [37]						-
60 [1500]		1.61 [41]						
64 [1600]		1.69 [43]						
66 [1650]		1.77 [45]						
72 [1800]		1.89 [48]	-					
80 [2000]		2.13 [54]						
84 [2100]	2.24 [57]							
88 [2200]	2.36 [60]							
96 [2400]	2.52 [64]	-						
104 [2600]	2.76 [70]							



CAUTION

Do not deflect the joint over the allowable deflection angle to avoid a leak.

III. Collar installation

1. Connecting two pipes successively with Collar

When the pipes and the Collar are serially laid from one side to the other side, the assembly procedure of the Collar is the same as that of the pipe except for the Lock Ring adjusting position on the pipe spigot.

The distance between spigots in the Collar (y1) shall follow the pipeline drawing.

Note: If the expansion and contraction performances of the Collar are set to be equal, Table-8 shall be used for the Lock Ring adjustment instead of Table-6.

Table-8 Lock Ring adjusting position on the spigot for Collar joint

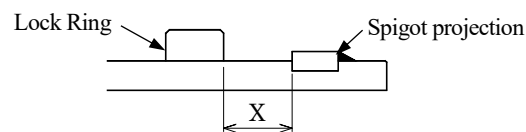

Pipe size, in. [mm]	X, in. [mm]
44 [1100]	4.3 [108.5]
48 [1200]	
54 [1350]	4.6 [116]
60 [1500]	4.5 [113.5]
64 [1600]	4.6 [117.5]
66 [1650]	
72 [1800]	

Pipe size, in. [mm]	X, in. [mm]
80 [2000]	4.5 [115]
84 [2100]	4.8 [122.5]
88 [2200]	
96 [2400]	4.9 [125]
104 [2600]	

2. Connecting two pipes to tie in with a Collar

Follow the steps below and the pipe assembly procedure when connecting two pipes to tie in with the Collar.

- (1) Ensure the previous and next pipes are aligned to avoid intense deflection at a connecting point.

 **CAUTION** If the pipes are misaligned, the connecting may fail.

(2) Adjust the distance of the Lock Ring position in Table-9 for each pipe to be connected.

Table-9 Lock Ring adjusting position on the spigot for tie-in

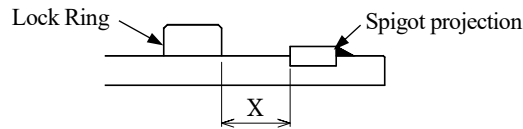

Pipe size, in. [mm]	X, in. [mm]	Pipe size, in. [mm]	X, in. [mm]
44 [1100]	2.8 [70]	80 [2000]	2.4 [60]
48 [1200]		2.8 [70]	84 [2100]
54 [1350]			88 [2200]
60 [1500]			96 [2400]
64 [1600]			104 [2600]
66 [1650]			
72 [1800]			

(3) Mark a Collar location (bell end) guideline on each spigot. The Collar location guidelines are to be determined to maintain the Collar at the center of the spigot gap (y1). Next, mark an assembly guideline on each spigot at the same distance from the spigot end. The assembly guidelines are auxiliary lines for the Collar location guidelines that will be hidden by the accessories. The assembly guidelines can be marked after placing the Collar at the center of the spigot gap (y1).

(4) Place the accessories (gland, Split Ring, Rubber Gasket, and Backup Ring) on the spigot of each pipe in the proper order.

(5) When connecting the Collar to the first pipe, install the Lock Ring in the Collar socket only on the side facing the pipe. Expand the Lock Ring, then place the entire Collar on the pipe. (See Figure-22)

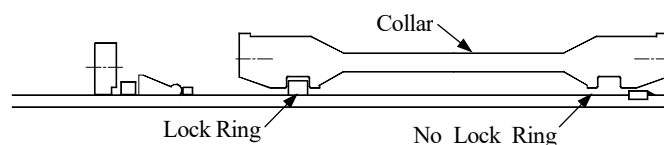
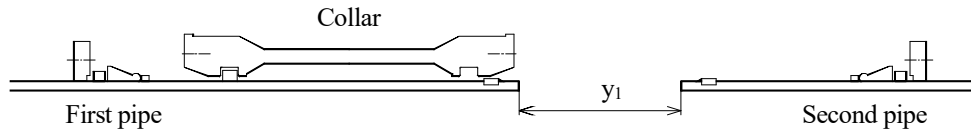

Figure-22 Collar on pipe spigot

(6) Lay the second pipe so that the distance between the pipe spigots conforms to the value in Table-10, then mate the two spigots.

Table-10 Standard distance between the pipe spigots for tie-in



Pipe size, in. [mm]	Standard distance y_1 , in. [mm]
44 [1100]	11.8 [300]
48 [1200]	
54 [1350]	12.2 [310]
60 [1500]	12.6 [320]
64 [1600]	12.8 [325]
66 [1650]	
72 [1800]	13.0 [330]
80 [2000]	13.2 [335]
84 [2100]	13.8 [350]
88 [2200]	
96 [2400]	
104 [2600]	14.6 [370]

- (7) Slide the Collar toward the second pipe slightly, then install the Lock Ring in the Collar socket. (See Figure-23.)

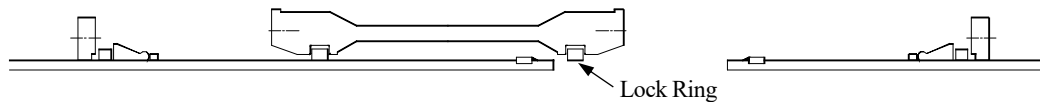

Figure-23 Installation of Lock Ring

- (8) Widen the Lock Ring with the Lock Ring Expander. Insert the Lock Ring Stopper between the Connecting Pieces I and II (Figure-24), then remove the expander.

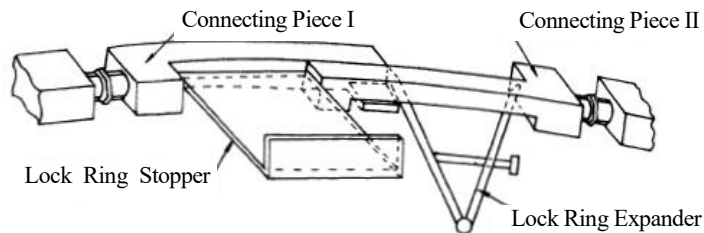

Figure-24 Lock Ring Stopper

- (9) Slide the Collar to adjust the center of the Collar at the middle of the standard distance y_1 .
(See Figure-25.)

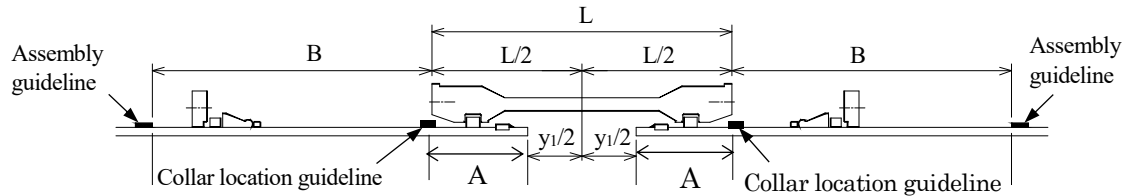

Figure-25 Final position of Collar

- (10) Assemble the Collar joints using the same procedure as pipes.
 Maintain the Collar position at the center.
 Check the center position of the Collar as the joints are assembled.
 Do not tighten only one side of the bolts to avoid shifting the correct Collar position.
 The assembly guidelines on both the spigots may be used to maintain the Collar at the center.

IV. Pipe cutting procedure (Field cutting is only available for 44" to 64" pipes.)

Field cutting and grooving are possible to fabricate the spigot projection on the cut end when connecting the cut-pipe spigot to the pipe socket. The Spigot Ring shall be installed in the groove. (See Figure-26.)

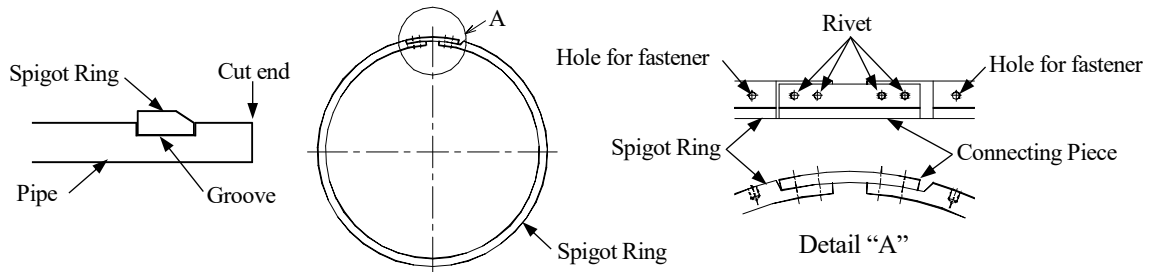

Figure-26 Spigot Ring for spigot projection

Sizes 44" to 64" are capable of field cutting and grooving. However, sizes over 64" require factory fabrication by a manufacturer.

1. Effective length of cut pipe

Figure-27 shows the effective length of the cut pipe. The effective length of the cut pipe includes the standard gap Y inside the socket.

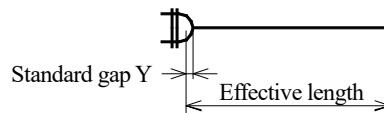

Figure-27 Effective length of cut pipe

Determine the effective length of the cut pipe by considering the distance y_1 in the Collar when connecting it to the Collar.

2. Pipe for cutting

Cut the Class 1 pipe only or the thicker pipe. The pipe for cutting is called a "gauged pipe." Use the gauged pipe for cutting. The gauged pipe can be identified by a white line marked around the neck of the bell.

3. Grooving of spigot

- (1) Groove the cut end using a special cutting and grooving machine. Keel Cutter shall be provided for this case. The location and dimensions of the groove are shown in Table-11.

Table-11 Location and dimensions of groove

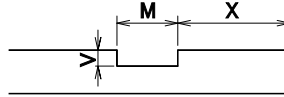

Pipe size	V		M		X	
	44" [1100 mm]	0.20" [5 mm]	+0.04" [+1.0 mm]	1.26" [32 mm]	+0.06" [+1.5 mm] -0.02" [-0.5 mm]	1.97" [50 mm]
48" [1200 mm]	-0.02" [-0.5 mm]		2.36" [60 mm]			
54" [1350 mm]						
60" [1500 mm]	0.24" [6 mm]	+0.06" [+1.5 mm]	1.46" [37 mm]	-0.02" [-0.5 mm]	2.17" [55 mm]	
64" [1600 mm]		-0.02" [-0.5 mm]				

- (2) Bevel the edges of the groove and the cut end with a file or a grinder.

- (3) Repair the groove and the cut end with the repair paint. Repair the cement lining as well if it is damaged.

4. Installing Spigot Ring for cut pipe

- (1) Clean the groove before installing the Spigot Ring.

- (2) Retain the Spigot Ring on the spigot with C-clamps from the bottom to the top (Figure-28). Ensure the cut portion of the Spigot Ring on the top.

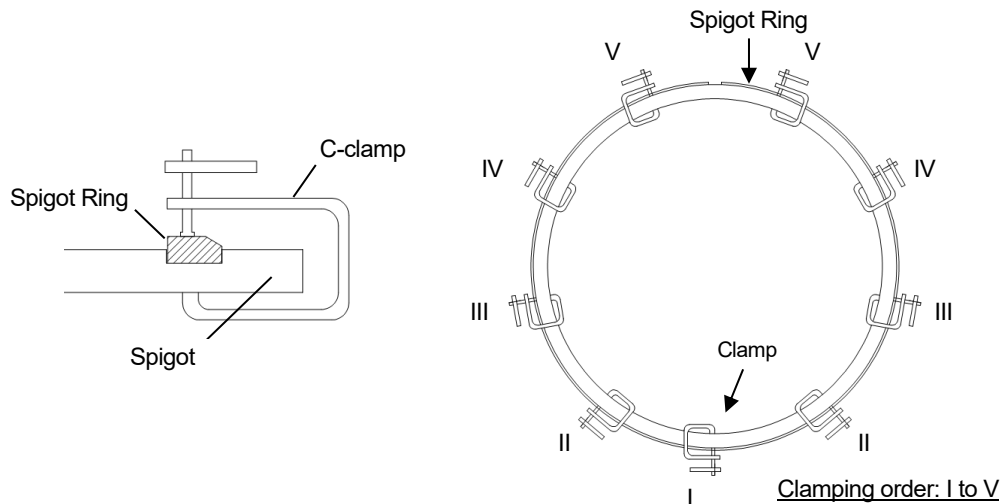

Figure-28 Retainment of Spigot Ring with clamps

Note: As an alternative method, Lock Ring Fastener can be used for set-up of the Spigot Ring following the procedure below.

- 1) Insert 1/4" bolts into the holes on the jaw of the Lock Ring Fastener.
- 2) Place the Spigot Ring in the groove, ensuring the proper orientation of the Spigot Ring.
- 3) Ensure the Spigot Ring is correctly installed in the groove and not displaced.
- 4) Insert the bolts on the Lock Ring Fastener into the holes on the Spigot Ring.
- 5) Tighten the fastener to retain the Spigot Ring in the groove. (See Figure-29.)

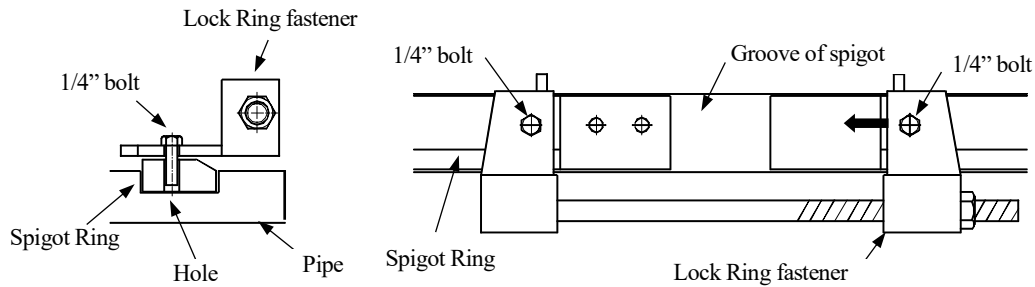

Figure-29 Installation of Spigot Ring in the groove of spigot

- (3) Tamp the Spigot Ring lightly with a soft head hammer to shift the tapered side against the wall of the groove at the spigot end. (See Figure-30.)

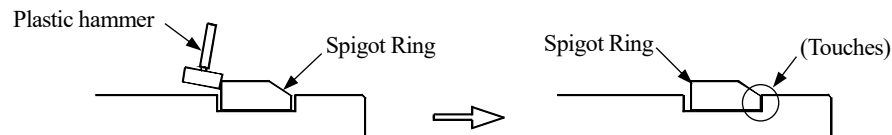

Figure-30 Correct position of Spigot Ring in the groove

- (4) Confirm by hand that the Spigot Ring is firm and rigid in the groove. Undo the process if the Spigot Ring is loose.

- (5) Attach the Connecting Piece to the Spigot Ring by inserting two rivets (five rivets are included as a set) into the holes of the Spigot Ring and the Connecting Piece (①, ② of Figure-31). Retain the Spigot Ring and Connecting Piece to the groove with a clamp. Drill two holes into the Spigot Ring through the Connecting Piece (③, ④ of Figure-31). A 3/16" (4.1-4.2 mm) diameter drill bit shall be used. Do not over-drill the Spigot Ring. This may damage the groove.

As an alternative method, the Spigot Ring can be removed from the groove and reinstalled in the groove after two holes are separately penetrated out of the groove.

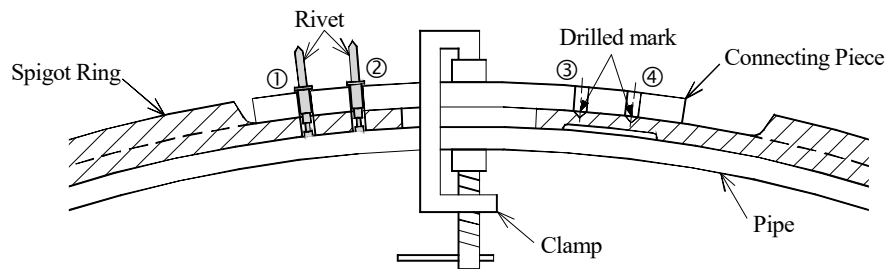

Figure-31 Assembly of Spigot Ring

- (6) Insert the other two rivets into the holes of the Spigot Ring and Connecting Piece (③, ④ of Figure-31). Start riveting in the order of Figure-32 (①, ②, ③ and ④). Ensure the rivet head is flat and flush with the Connecting Piece. Undo the riveting process if the rivet head is protruded from the Connecting Piece.

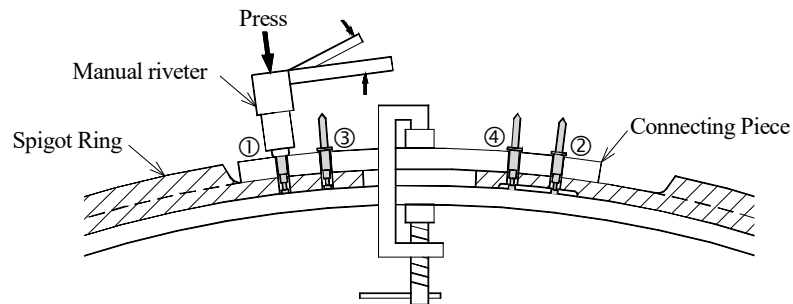



Figure-32 Riveting of Spigot Ring and Connecting Piece

- (7) Remove the clamp. Confirm by hand that the Spigot Ring is firm and rigid in the groove. Undo the process if the Spigot Ring is loose.
- (8) An assembly guideline may be marked on the spigot to indicate the insertion depth.

ASSEMBLING PROCEDURE OF S JOINT (Inch ver.)				 KUBOTA CORPORATION
Doc. No. L-S-J1-I	September, 2024	Rev. 0	Page 23 of 24	

VI. Disassembling procedure

- (1) Remove all nuts.
- (2) Shift the gland and the Split Ring approximately 20" from the bell end.
- (3) Remove the Rubber Gasket and the Backup Ring with a flat screwdriver or a pry bar.
Lubricant or water may be applied to remove the Rubber Gasket smoothly. Never damage the threads of the stud bolts during this step.
- (4) Remove the Connecting Piece III by tightening the Lock Ring Fastener for disengaging the Lock Ring.
- (5) Pull out the spigot until the spigot projection comes into contact with the Lock Ring.
- (6) Spread the Lock Ring with the fastener.
- (7) Insert 6 to 8 wedge plates underneath the Lock Ring, ensuring the edge of the wedge plate is beyond the spigot projection. (See Figure-33.) Two flat screwdrivers may be inserted underneath the edges of the Connecting Piece II and III to facilitate the plate insertion.

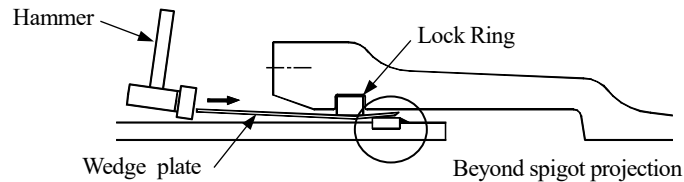

Figure-33 Inserting wedge plates for disassembly

- (8) Align the pipe, then pull out the spigot slowly from the socket.

Note: Do not reuse the Rubber Gasket.

Annex

Special Tools for S Joint

Description		Quantity	Remarks
1. Joint assembly			
(1)	Lock Ring Fastener	1	
(2)	Thickness gauge (1.0 mm thick)	1	
(3)	Lock Ring Expander	1	
(4)	Insertion rod	1	
(5)	Torque wrench (200 N-m or 150 ft-lb)	1	Provided by a user
(6)	Wedge for gland centering	2	Provided by a user
(7)	Joint spacers	4	
(8)	Lock Ring Stopper	1	Stopper used for tie-in process
(9)	Lubricant	-	
2. Spigot projection formation of cut pipe			
(1)	Pipe cutting & grooving machine	1	
(2)	Lock Ring Fastener	1	
(3)	C-clamp	1 (10*)	Provided by a user * If used for Spigot Ring installation
(4)	Drill & 3/16"-dia. drill bit	1	Provided by a user
(5)	Hand riveter	1	Provided by a user
(6)	Grinder or file	1	Provided by a user
(7)	Repair paint for cut pipe	1	Paint for ductile iron pipe
3. Joint disassembly			
(1)	Wedge plate	8	